

# TABLES

## Straight edges tables – Comfort

The "Comfort" range is designed for smallscale catering sites as well as restaurants. This functional range is designed to offer excellent value for money with a limited number of products.



SCAN ME and download all the technical datasheets of the range!



### CASTORS VERSION...



Swivelling polyamid castors

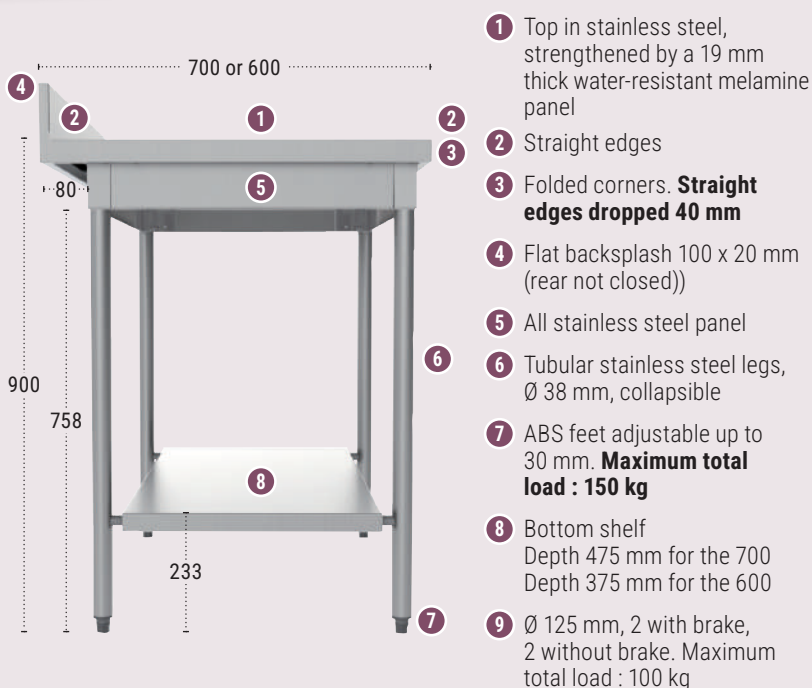

**Safety:** 3 fold edges which avoid any deposit and hidden infections, and eliminate any risks of cutting.

All stainless steel work top = **increase longevity.**

All stainless steel header = **easy to clean** and durable.



## turn'fix

**Tool-free mounting of the legs, easy and quick**

- 1 Easier
- 2 Quicker
- 3 More robust



SCAN ME for the turn'fix video!

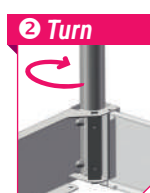
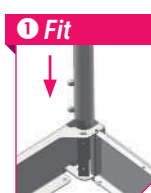

## Collapsible tables

On ABS feet

Standard



HEIGHT  
900 mm

CENTRAL TABLES

CENTRAL TABLES  
+ BOTTOM SHELF

TABLES WITH BACKSPLASH

TABLES WITH BACKSPLASH  
+ BOTTOM SHELF

### WIDTH 600

L x D mm	Kg	Ref.	Kg	Ref.	Kg	Ref.	Kg	Ref.
600 x 600	17.6	<b>TC606</b>	21.2	<b>TCEG606</b>	18	<b>TD606</b>	20.4	<b>TDEG606</b>
1000 x 600	24.1	<b>TC610</b>	29.7	<b>TCEG610</b>	24.2	<b>TD610</b>	29.8	<b>TDEG610</b>
1200 x 600	27.3	<b>TC612</b>	34	<b>TCEG612</b>	27.5	<b>TD612</b>	34.2	<b>TDEG612</b>
1400 x 600	31	<b>TC614</b>	38.8	<b>TCEG614</b>	31.6	<b>TD614</b>	39.3	<b>TDEG614</b>
1500 x 600	32.2	<b>TC615</b>	40.7	<b>TCEG615</b>	33.7	<b>TD615</b>	42.1	<b>TDEG615</b>
1600 x 600	34.4	<b>TC616</b>	43.2	<b>TCEG616</b>	35.7	<b>TD616</b>	44.6	<b>TDEG616</b>
1800 x 600	37.6	<b>TC618</b>	47.5	<b>TCEG618</b>	37.5	<b>TD618</b>	47.4	<b>TDEG618</b>
2000 x 600	40.8	<b>TC620</b>	51.5	<b>TCEG620</b>	41.6	<b>TD620</b>	52.4	<b>TDEG620</b>
2200 x 600	44	<b>TC622</b>	56.4	<b>TCEG622</b>	46	<b>TD622</b>	58.1	<b>TDEG622</b>

### WIDTH 700

L x D mm	Kg	Ref.	Kg	Ref.	Kg	Ref.	Kg	Ref.
700 x 700	21	<b>TC707</b>	25.5	<b>TCEG707</b>	22.8	<b>TD707</b>	27.6	<b>TDEG707</b>
800 x 700	23	<b>TC708</b>	28.2	<b>TCEG708</b>	24.5	<b>TD708</b>	29.8	<b>TDEG708</b>
1000 x 700	26.8	<b>TC710</b>	33.5	<b>TCEG710</b>	27.9	<b>TD710</b>	34.6	<b>TDEG710</b>
1200 x 700	30.6	<b>TC712</b>	38.7	<b>TCEG712</b>	31.2	<b>TD712</b>	39.4	<b>TDEG712</b>
1400 x 700	34.2	<b>TC714</b>	43.4	<b>TCEG714</b>	34.6	<b>TD714</b>	43.9	<b>TDEG714</b>
1500 x 700	36.3	<b>TC715</b>	47	<b>TCEG715</b>	36.3	<b>TD715</b>	47.1	<b>TDEG715</b>
1600 x 700	38.4	<b>TC716</b>	49.3	<b>TCEG716</b>	40	<b>TD716</b>	50.9	<b>TDEG716</b>
1800 x 700	42	<b>TC718</b>	54	<b>TCEG718</b>	43.3	<b>TD718</b>	55.2	<b>TDEG718</b>
2000 x 700	45.8	<b>TC720</b>	59.1	<b>TCEG720</b>	46.7	<b>TD720</b>	60	<b>TDEG720</b>
2200 x 700	49.5	<b>TC722</b>	64.7	<b>TCEG722</b>	50	<b>TD722</b>	65	<b>TDEG722</b>

Shipping within 48h

► **CUSTOMIZED** / See collapsible tables on ABS feet page 34

## On polyamid castors

Standard



HEIGHT  
900 mm

CENTRAL TABLES

CENTRAL TABLES  
+ BOTTOM SHELF

TABLES WITH BACKSPLASH

TABLES WITH BACKSPLASH  
+ BOTTOM SHELF

### WIDTH 600

L x D mm	Kg	Ref.	Kg	Ref.	Kg	Ref.	Kg	Ref.
600 x 600	19	<b>TC606RP</b>	22.6	<b>TCEG606RP</b>	20	<b>TD606RP</b>	21.7	<b>TDEG606RP</b>
1000 x 600	25.5	<b>TC610RP</b>	31	<b>TCEG610RP</b>	25.6	<b>TD610RP</b>	31.1	<b>TDEG610RP</b>
1200 x 600	28.8	<b>TC612RP</b>	35.3	<b>TCEG612RP</b>	29	<b>TD612RP</b>	35.5	<b>TDEG612RP</b>
1400 x 600	32.5	<b>TC614RP</b>	40.1	<b>TCEG614RP</b>	33	<b>TD614RP</b>	40.7	<b>TDEG614RP</b>
1500 x 600	33.6	<b>TC615RP</b>	42	<b>TCEG615RP</b>	35.1	<b>TD615RP</b>	43.4	<b>TDEG615RP</b>
1600 x 600	35.8	<b>TC616RP</b>	44.5	<b>TCEG616RP</b>	37.1	<b>TD616RP</b>	45.9	<b>TDEG616RP</b>
1800 x 600	39	<b>TC618RP</b>	48.8	<b>TCEG618RP</b>	39.5	<b>TD618RP</b>	48.7	<b>TDEG618RP</b>
2000 x 600	42.2	<b>TC620RP</b>	53	<b>TCEG620RP</b>	43	<b>TD620RP</b>	54	<b>TDEG620RP</b>
2200 x 600	46	<b>TC622RP</b>	57.7	<b>TCEG622RP</b>	47	<b>TD622RP</b>	59.4	<b>TDEG622RP</b>

### WIDTH 700

L x D mm	Kg	Ref.	Kg	Ref.	Kg	Ref.	Kg	Ref.
700 x 700	22	<b>TC707RP</b>	26.9	<b>TCEG707RP</b>	24.3	<b>TD707RP</b>	28.9	<b>TDEG707RP</b>
800 x 700	24.4	<b>TC708RP</b>	29.5	<b>TCEG708RP</b>	25.6	<b>TD708RP</b>	31.1	<b>TDEG708RP</b>
1000 x 700	28.2	<b>TC710RP</b>	34.8	<b>TCEG710RP</b>	29.3	<b>TD710RP</b>	35.6	<b>TDEG710RP</b>
1200 x 700	32	<b>TC712RP</b>	40	<b>TCEG712RP</b>	32.7	<b>TD712RP</b>	40.7	<b>TDEG712RP</b>
1400 x 700	35.6	<b>TC714RP</b>	44.8	<b>TCEG714RP</b>	36	<b>TD714RP</b>	45.2	<b>TDEG714RP</b>
1500 x 700	37.7	<b>TC715RP</b>	48.3	<b>TCEG715RP</b>	38	<b>TD715RP</b>	48.4	<b>TDEG715RP</b>
1600 x 700	39.8	<b>TC716RP</b>	50.6	<b>TCEG716RP</b>	41.4	<b>TD716RP</b>	52.3	<b>TDEG716RP</b>
1800 x 700	43.4	<b>TC718RP</b>	55.2	<b>TCEG718RP</b>	44.8	<b>TD718RP</b>	56.5	<b>TDEG718RP</b>
2000 x 700	47.2	<b>TC720RP</b>	61	<b>TCEG720RP</b>	48.1	<b>TD720RP</b>	61.4	<b>TDEG720RP</b>
2200 x 700	51.2	<b>TC722RP</b>	65	<b>TCEG722RP</b>	51.5	<b>TD722RP</b>	66	<b>TDEG722RP</b>

Shipping within 48h

► **CUSTOMIZED** / See collapsible tables on polyamid castors page 34

**OPTIONS**  
pages 58-59



**ACCESSORIES**  
page 60





## Bottom shelves (individually packed)

### Solid bottom shelf

- Straight edges dropped 35 mm



EGZ712

### Racks bottom shelf

- Straight edges
- 35 x 35 mm stainless steel square tubes

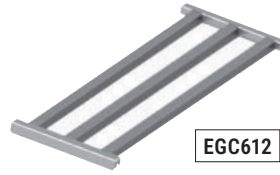

EGC612



EGC712

#### Full

For table length mm	WIDTH 600		WIDTH 700	
	Kg	Ref.	Kg	Ref.
600	3.5	EGZ606		EGZ706
700		-	4.7	EGZ707
800		-	5.2	EGZ708
1000	5	EGZ610	6	EGZ710
1200	6	EGZ612	8	EGZ712
1400	7	EGZ614	9	EGZ714
1500	7.5	EGZ615	10	EGZ715
1600	8	EGZ616	11	EGZ716
1800	9	EGZ618	12	EGZ718
2000	10	EGZ620	13	EGZ720
2200	11	EGZ622	13	EGZ722

#### Racks

For table length mm	WIDTH 600		WIDTH 700	
	Kg	Ref.	Kg	Ref.
600	3.4	EGC606		-
700		-	5	EGC707
800		-	7	EGC708
1000	5.2	EGC610	7	EGC710
1200	6	EGC612	8.2	EGC712
1400	6.5	EGC614	9.4	EGC714
1500	7	EGC615	10	EGC715
1600	7.4	EGC616	10.7	EGC716
1800	8	EGC618	12	EGC718
2000	9	EGC620	13.2	EGC720
2200	9.5	EGC622	14.5	EGC722

## Table shelves

- Shelf: stainless steel
- Legs: Ø 38 mm tubular stainless steel
- 1st level: 400 mm from the worktop
- 2nd level: 600 mm from the worktop
- To be fixed on the table (hole to be made, template and screws are supplied)



TD + EGS



EGSCOR

FOR TABLE LENGTH	DIM. SHELF	1 LEVEL (HEIGHT 400 MM)		2 LEVELS (HEIGHT 600 MM)	
		Kg	Ref.	Kg	Ref.
mm	L x D mm				
1000	960 x 300	5.5	EGS110	11.7	EGS210
1200	1160 x 300	6.5	EGS112	13.3	EGS212
1400	1360 x 300	7.5	EGS114	14.9	EGS214
1500	1460 x 300	7.5	EGS115	16	EGS215
1600	1560 x 300	8	EGS116	16.6	EGS216
1800	1760 x 300	9.5	EGS118	19	EGS218
2000	1960 x 300	11	EGS120	22	EGS220

Shipping within 48h

OPTION : Stainless steel angles	Ref.
Set of 4 angles with stud, for fixing EGS shelf on the lateral side of a top (for fixation on existing element for example)	EGSCOR



1 or 2 shelf levels.  
**Designed round legs, suitable for collapsible tables.**  
**Space saving:** frees up the entire worktop surface, can be used as a serving hatch on a central table.

➤ **CUSTOMIZED** / Different lengths, +25 % of the price of the standard lower length (max. 2200)

## Customized collapsible tables

On ABS feet

Customized



HEIGHT  
900 mm

CENTRAL TABLES

CENTRAL TABLES  
+ BOTTOM SHELF

TABLES WITH  
BACKSPLASH

TABLES WITH  
BACKSPLASH  
+ BOTTOM SHELF

### WIDTH 600 TO 800 MM

Length	Legs	Ref.	Ref.	Ref.	Ref.
600 to 1000	4	TC7-10	TCEG7-10	TD7-10	TDEG7-10
1001 to 1200	4	TC7-12	TCEG7-12	TD7-12	TDEG7-12
1201 to 1400	4	TC7-14	TCEG7-14	TD7-14	TDEG7-14
1401 to 1600	4	TC7-16	TCEG7-16	TD7-16	TDEG7-16
1601 to 1800	4	TC7-18	TCEG7-18	TD7-18	TDEG7-18
1801 to 2000	4	TC7-20	TCEG7-20	TD7-20	TDEG7-20
2001 to 2200	4	TC7-22	TCEG7-22	TD7-22	TDEG7-22

On polyamid castors

Customized



HEIGHT  
900 mm

CENTRAL TABLES

CENTRAL TABLES  
+ BOTTOM SHELF

TABLES WITH  
BACKSPLASH

TABLES WITH  
BACKSPLASH  
+ BOTTOM SHELF

### WIDTH 600 TO 800 MM

Length	Legs	Ref.	Ref.	Ref.	Ref.
600 to 1000	4	TC7-10RP	TCEG7-10RP	TD7-10RP	TDEG7-10RP
1001 to 1200	4	TC7-12RP	TCEG7-12RP	TD7-12RP	TDEG7-12RP
1201 to 1400	4	TC7-14RP	TCEG7-14RP	TD7-14RP	TDEG7-14RP
1401 to 1600	4	TC7-16RP	TCEG7-16RP	TD7-16RP	TDEG7-16RP
1601 to 1800	4	TC7-18RP	TCEG7-18RP	TD7-18RP	TDEG7-18RP
1801 to 2000	4	TC7-20RP	TCEG7-20RP	TD7-20RP	TDEG7-20RP
2001 to 2200	4	TC7-22RP	TCEG7-22RP	TD7-22RP	TDEG7-22RP

OPTIONS  
pages 58-59



ACCESSORIES  
page 60



T65MER

## Multi-services tables

- Work top in stainless steel
- Delivered with 1 adjustable bottom shelf
- Ø 38 mm stainless steel tubular legs, with levellers adjustable up to 30 mm or castors Ø 50 mm (2 with brakes)
- Delivered flat packed

Designation	L x D x H mm	Kg	Ref.
With adjustable levellers	663 x 538 x 848	17	T65ME
With castors	663 x 538 x 848	18	T65MER

48h Shipping within 48h



Especially designed to receive slicers, bread slicers, vegetable cutters, mincing machines etc



## Drawers for collapsible tables

- Telescopic runners in stainless steel
- Fixing with screws
- Max. load per drawer: 5kg in use



Reinforced drawers  
All stainless steel runners

Designation	L x D x H mm	Kg	Ref.
<b>Drawer for table width 600</b> 1 GN2/3 stainless steel tray H 100 mm	370 x 467 x 127	6	<b>TTIRG06</b>

Shipping within 48h

TTIRG06



Designation	L x D x H mm	Kg	Ref.
<b>Drawer for table width 700</b> + 1 GN1/1 stainless steel tray H 100 mm	370 x 567 x 127	8	<b>TTIRG10B</b>
<b>Drawer for table width 800</b> + 1 GN1/1 stainless steel tray H 100 mm	370 x 667 x 127	8.5	<b>TTIRG08</b>

Shipping within 48h

TTIRG10B

TTIRG08



## GN1/1 Hanging 3 drawers unit

- For collapsible tables only 700 mm width and a length greater than 1000 mm
- Recessed handles
- Supplied with 3 x GN1/1 polycarbonate gastronorm containers
- On stainless steel runners

FOR 700 MM WIDTH TABLES		
L x D x H mm	Kg	Ref.
420 x 583 x 556	24	<b>TTIR3G10B</b>



The installation of a bottom shelf under the table is not compatible with the 3 drawers unit TTIR3G10B



Strengthened drawers  
Stainless steel runners



TD712 (see page 32) + 1 TTIR3G10B



**OPTIONS**  
pages 58-59



**ACCESSORIES**  
page 60



## Chef tables

- All stainless steel
- Basin : stainless steel, welded, 400 x 400 x 250 mm
- Supplied with plug, overflow pipe and PVC U bend
- Tap hole Ø 31 mm (optional cover)

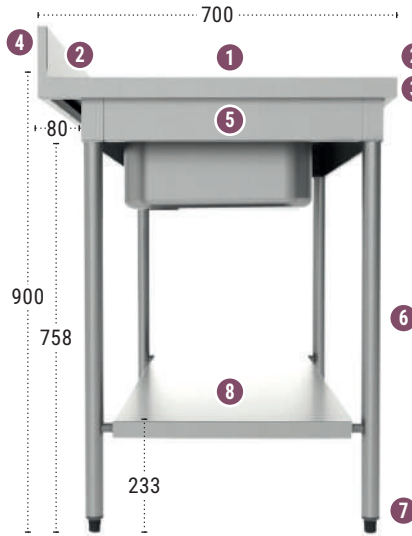

- 1 Top in stainless steel strengthened by a 19 mm thick water-resistant melamine panel
- 2 Straight edges
- 3 Welded corners. Straight edges dropped 40 mm
- 4 Flat backsplash
- 5 All stainless steel panel
- 6 Tubular stainless steel legs 38 mm, collapsible
- 7 ABS feet adjustable up to 30 mm
- 8 Optional bottom shelf EG type - Depth 475 mm

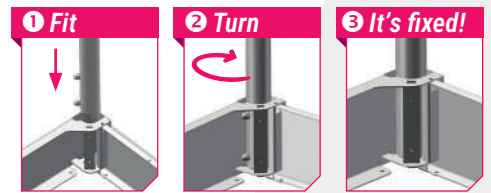

turn'fix

- Tool-free mounting of the legs, easy and quick





L x D x H mm	Kg			OPTIONAL BOTTOM SHELF	
		SINK ON THE RIGHT Ref.	SINK ON THE LEFT Ref.	Kg	Ref.
1200 x 700 x 900	29	TH12CD	TH12CG	8	EG712
1400 x 700 x 900	34	TH14CD	TH14CG	9.5	EG714
1500 x 700 x 900	36	TH15CD	TH15CG	10	EG715
1600 x 700 x 900	39	TH16CD	TH16CG	11	EG716
1800 x 700 x 900	43	TH18CD	TH18CG	12	EG718
2000 x 700 x 900	48	TH20CD	TH20CG	13.3	EG720

 Shipping within 48h

## Chef furniture

- Entirely in stainless steel
- Half-sized back to insert pipework
- 2 hanging sliding doors - Lock - No shelf
- Work top : in stainless steel, reinforced with a 19 mm thick water-resistant melamine panel - Welded corners, straight edges dropped 40 mm
- Flat backsplash 100 x 20 mm, rear not closed
- Sink: stainless steel, welded, L x D x H : 400 x 400 x 250 mm
- Supplied with plug, simple overflow pipe and PVC U bend
- Tap hole Ø 31 mm (optional cover)
- Black ABS feet H 155 mm adjustable up to 70 mm
- Without inner shelf



L x D x H mm	Kg		
		SINK ON THE RIGHT Ref.	SINK ON THE LEFT Ref.
1200 x 700 x 900	48	MH112CD	MH112CG
1400 x 700 x 900	54	MH114CD	MH114CG
1600 x 700 x 900	60	MH116CD	MH116CG

**OPTIONS**  
pages 58-59



**ACCESSORIES**  
page 60



OPTIONS FOR CHEF FURNITURE  
4 stainless steel castors Ø 125 mm (2 with brake)  
Add RX to the end of the reference



## Options for standard and customized tables

Std : standard,  
CM : customized,  
Chef and Can : Chef table and can opening table.

### FOR TABLES WITH

Designation	STRAIGHT EDGES		ROUNDED EDGES			Ref.
	Std & CM	Std	CM	Chef & Can CM		
<b>Legs / feet &amp; castors</b>						
4 stainless steel feet - Add "X" to the end of the reference	✓	✓	✓	✓	✓	.../X
6 stainless steel feet (for length upper than 2200 mm) - Add "X" to the end of the reference		✓	✓	✓	✓	.../X
2 stainless steel feet for semi-suspended table - Add "X" to the end of the reference		✓	✓	✓	✓	.../X
4 stainless steel castors Ø 125 mm (2 with brake) - Add "RX" to the end of the reference	✓	✓	✓	✓	✓	.../RX
6 stainless steel castors Ø 125 mm (2 with brake) for length upper than 2200 mm - Add "RX" to the end of the reference	✓	✓	✓	✓	✓	.../RX
4 polyamid castors Ø 125 mm (2 with brake) - Add "RP" to the end of the reference	✓	✓	✓	✓	✓	.../RP
6 polyamid castors Ø 125 mm (2 with brake) for length upper than 2200 mm - Add "RP" to the end of the reference	✓	✓	✓	✓	✓	.../RP
<b>Semi-mobile option</b> For tables legs upper than 2200 mm (3 castors + 3 feet), prices x 1,5		✓	✓	✓	✓	.../SMP
2 castors polyamid cover without brake et 2 ABS feet - Add "SMP" to the end of the reference.	✓	✓	✓	✓	✓	.../SMP
2 castors stainless cover without brake and 2 stainless steel feet - Add "SMX" to the end of the reference	✓	✓	✓	✓	✓	.../SMX
<b>Added value for special height legs for standard table.</b> For tray height 1050 mm maxi (otherwise consult us). Specify the desired height of the material when ordering.	Std	✓				.../SPHT
<b>Supplement for 2 hanging consoles on customized table</b> (supplement to add to the price of a table on 4 ABS adjustable legs) - 3 consoles upper than 2200 mm, price x1,5				✓	✓	TOP16
<b>Supplement for 2 semi hanging consoles on customized table</b> (supplement to add to the price of a table on 4 ABS adjustable legs) - 3 consoles upper than 2200 mm, price x1,5				✓	✓	TOP17
<b>Structure &amp; reinforcement</b>						
<b>Lateral and longitudinal bottom crosspieces</b> (U or H shape: please notify on the order) - Option non available on suspended and semi-suspended tables. For tables with 6 feet, prices x 1,5.		✓	✓	✓	✓	TRAV
<b>4 feet welded on the side strips</b> For tables with 6 feet, prices x 1,5		✓	✓	✓	✓	SPSOUD
<b>Panels &amp; trims</b>						
<b>Stainless steel panels (3 faces)</b> for standard chef table and can opening table on 4 feet (package)	Chef	Chef & Can				TOP14
<b>Stainless steel panels (3 faces)</b> for standard suspended and semi-suspended tables		Chef & Can				TOP15
<b>Stainless steel panels (3 faces)</b> for customized chef table on feet or hanging (the linear metre of frontage, minimum 1 m)				✓		POPT04
<b>Knee operated</b> - Delivered with front panel with premixer, sawn neck and push tap (option only available on chef table with sink cover option)		Chef & Can		✓		CEAUV

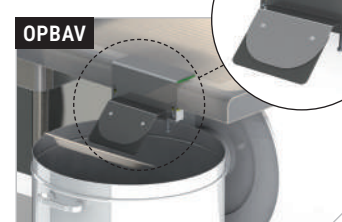



# Options for standard and customized tables

Std : standard,  
CM : customized,  
Chef and Can : Chef table and can opening table.

FOR TABLES WITH

Designation		STRAIGHT EDGES		ROUNDED EDGES		Ref.	
		Std & CM	Std	CM	Chef & Can CM		
<b>Backsplashes</b>							
Rear backsplash closure (package)		✓	✓	✓	✓	TFD	
Rear backsplash height 300 mm (per lm, minimum 1 lm)				✓	✓	TOP12	
Manufactured side backsplash 100 x 20 mm integrated on the worktop. Possibility of adding 2 side sheet metal backsplashes up to 2700 mm. Warning, only 1 side sheet metal backsplash from 2701 to 2800 mm max.				✓	✓	TDL	
Side raised backsplash : Welded and siliconed, rear not closed	For tables width 600 mm	On the right	Std			TTDR610D	
		On the left	Std			TTDR610G	
	For tables width 700 mm	On the right	Std			TTDR710D	
		On the left	Std			TTDR710G	
Side raised backsplash : SWelded and siliconed, rear not closed	For tables width 600 mm	On the right		✓		TTDR610AD	
		On the left		✓		TTDR610AG	
	For tables width 700 mm	On the right		✓		TTDR710AD	
		On the left		✓		TTDR710AG	
<b>Bumpers &amp; protections</b>							
Rear bumpers : 2 rear bumpers in AISI 304L stainless steel with soldered 25x25 section on the back of tables with backsplash - Wall protected by 2 black ABS stops - 35 mm gap between backsplash and wall for easier cleaning		✓	✓	✓	✓	TTBA2	
Corner bumpers : Set of 4 corner bumpers fixed on the corners of the central table For tables with backsplash, add the TFD option		✓	✓	✓	✓	TTCP4	
Rubber squeegee / bib fixed on table to empty the plates (trash cans below)		✓	✓	✓	✓	OPBAV	
<b>Tap hole(s)</b>							
Table without tap hole				Chef & Can	✓	SPST	
Table with 2 tap holes				Chef & Can	✓	SPBT	
<b>Cut-out and finishing of the worktop (check feasibility with our teams before costing)</b>							
Tray thickness 2 mm instead of 1.5 mm (per lm, minimum 1 lm)					✓	✓	TOP11
Cut-out for post for central table					✓	✓	TOP01
Special cut-out in corner					✓	✓	TOP02
Rectangular cut-out in the worktop					✓	✓	TOP03
Angle-cut corner					✓	✓	TOP04
Cut-out for post in corner with backsplash					✓	✓	TOP05
Cut-out for post with backsplash For table with backsplash					✓	✓	TOP06
Vibrated polishing (in circles) (per lm, minimum 1 lm)	Central table				✓	✓	TOP09
	Table with backsplash				✓	✓	TOP10
Waste hole With rubber plug Ø 165 mm		CM			✓	✓	TTVDC

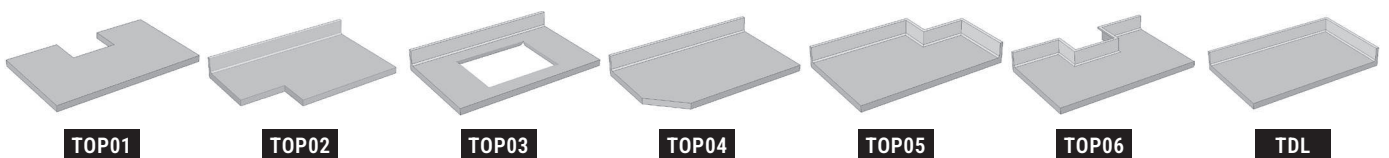



# Accessories for standard and customized tables

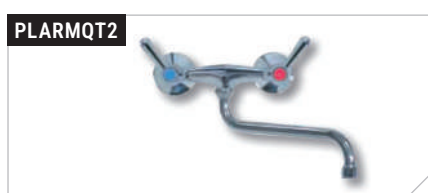
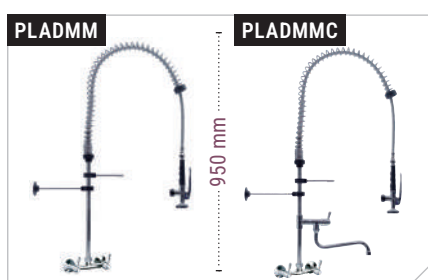
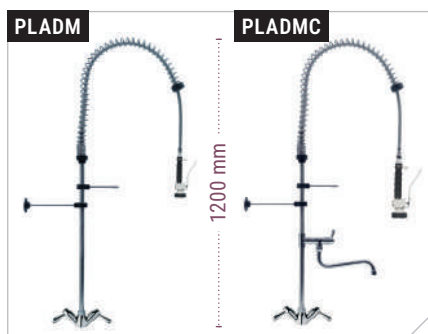

Designation		Ref.		
<b>Faucet to fix on sink</b>				
<b>Mixer spray-heads to fix on sink - Height 1200 mm</b>				
Fixed to the table + wall fixing bracket - Stainless steel AISI 304L - Mixer with non-return valves according to European standard EN13959 - Safety spring - Flexible I. 1200 mm in AISI 304L stainless steel braid + EPDM standard, nd 12.5 - Flow rate in liters per minute for a pressure of 3/4 bars: 17 l/ min - Total height: 1200 mm - Ergonomic grips with turn valve head - HW/CW taps with high-quality ceramic head - Spray head in stainless steel interior according to European standards CE, ROHS and ACS				
Without drawing tap		<b>PLADM</b>		
With drawing tap with swivel telescopic spout		<b>PLADMC</b>		
<b>Mixer spray-heads Mignon model - Height 700 mm</b>				
Ideal to go under the wall cabinets				
Without drawing tap		<b>PLADMGNON</b>		
With drawing tap with swivel telescopic spout		<b>PLADMCGNON</b>		
1/4 turn tap : Single hole with swan's neck		<b>PLARQT1</b>		
Mixer tap : Single hole		<b>PLAROBIML</b>		
<b>Wall faucet</b>				
<b>Wall mixer spray-heads</b>				
Idem PLADMC except : wall fixation, height 950 mm				
Without drawing tap		<b>PLADMM</b>		
With drawing tap with swivel telescopic spout		<b>PLADMMC</b>		
<b>Wall mixer taps</b>				
Twin-hole - 1/4 turn - Wall fixation - Spout length 250 mm				
Swivel spout from below		<b>PLARMQT2</b>		
Swivel spout from above		<b>PLARMQT3</b>		
Chromed cover : For the tap hole		<b>CT50</b>		
<b>U bends</b>				
PVC		<b>PLASIPHPL</b>		
Chromed brass		<b>PLASIPHLA</b>		
<b>Plug</b>				
Perforated overflow pipe* : Makes catching waste easier and prevents the risk of the U bend getting blocked		H180 mm	<b>POPTUB18</b>	<b>POPTUBPL18</b>
		H230 mm	<b>POPTUB23</b>	<b>POPTUBPL23</b>
		H280 mm	<b>POPTUB28</b>	<b>POPTUBPL28</b>
		H350 mm	<b>POPTUB35</b>	<b>POPTUBPL35</b>
		H430 mm	<b>POPTUB43</b>	<b>POPTUBPL43</b>
<b>Wall mounted detergent dispenser : Spring pump with automatic refill - Adjustable and secure dosage of 5 to 30 cc by pressure - Polypropylene body - Valves - ABS push button - Wall mounting and maintenance completely without tools</b>				
		<b>PLSAV</b>		
<b>Straight sink exhaust pipe without tap** : Tubular Ø 42,4 mm without valve - Non available on sink with integral bottom shelf</b>				
Simple		<b>PLAVISV*</b>		
Double Y		<b>PLAVIDSV*</b>		
<b>Straight sink exhaust pipe with tap(s)** : With 1/4 40 x 49 female turn(s) and AISI 304L stainless steel outlet pipe(s) (distance from floor about 80 mm depending on) - Non available on sink with integral bottom shelf</b>				
Simple		<b>PLAVI*</b>		
Double Y		<b>PLAVID*</b>		